



International HVAC&R Exhibition

**18-20
Nov
2025**

**Recinto Ferial
ifema.es**

Innovation for decarbonisation.

Exhibitor's guide and
specific rules of
participation

LIVE  **Connect**
365D IMPACT · CREATE COMMUNITY · GROW

Coinciding with:

 **matelec**

 **genera**

 **IFEMA
MADRID**

INDEX

1. HOW TO PARTICIPATE

- 1.1 Dates, schedule, and venue. Invited sectors
- 1.2 What do I need to do to participate?
- 1.3 Space allocation and contracting
- 1.4 Participation options
- 1.5. LIVE Connect: the digital platform accessible with your exhibitor plan
- 1.6. Your space at the fair. Stand types
- 1.7 Participation fees
- 1.8 Deadlines and payment methods
- 1.9 Specific fair regulations
- 1.10 Exhibitor calendar

2. MANAGE YOUR PARTICIPATION

- 2.1 Expo Zone. Manage your participation and space. Additional services contracting. E-commerce
- 2.2 Registration of co-exhibitors
- 2.3 Exhibitor passes and invitations. Visas. Vouchers and discounts
- 2.4 Other relevant information
- 2.5 Map
- 2.6 FAQs

3. PROMOTE AND MAXIMIZE YOUR PARTICIPATION

- 3.1 Exhibitor Catalogue
- 3.2 Invitations for your clients and contacts
- 3.3 Networking
- 3.4 Outdoor advertising
- 3.5 Innovation Gallery

4. SUSTAINABILITY MANAGEMENT AT IFEMA MADRID

5. CONTACT US

1.1 Dates, Schedule, and Venue. Invited Sectors

C&R will take place at IFEMA Madrid's venue from November 18 to 20, 2025. The opening hours are from 10:00 AM to 7:00 PM from Tuesday, November 18 to Thursday, November 20.

Exhibitors will have access to the venue starting at 9:00 AM and must leave by 7:30 PM.

The virtual event via the LIVE Connect platform will be open from September 15 to December 18, 2025.

The fair is for **professional attendees only**.

To apply for participation, companies, public or private organizations must belong to the sectors covered by the fair: **HVAC and Refrigeration**.

1.2 What Do I Need to Do to Participate?

To apply for participation, you must complete the **Participation Request Form** online, available on the fair's [website](#) within the established deadline, and submit proof of payment for the reservation fee.

Submitting the Participation Request implies full acceptance of [the General Participation Rules](#) for events organized by IFEMA Madrid, the technical annexes, the specific rules for this edition, and any general or specific provisions established by the fair organizers.

The exhibiting company is the company in whose name the application to participate as an exhibitor is completed.

In order to apply to participate in the fair, it is an essential requirement that the activity of the company, public or private entity, is included in the sectors covered by the fair within the sectors covered by the fair.

By clicking on the send application button, the exhibitor confirms to IFEMA MADRID that he/she is seriously interested in participating in the fair.

MADRID that it is seriously interested in participating as an exhibitor and in receiving a proposal.

The decision to accept the exhibitor will be at the discretion of IFEMA MADRID taking into account the purpose of the fair and the availability of space. IFEMA MADRID will make one or more proposals for space/location depending on the type of participation and/or type and size of stand requested.

This proposal constitutes a contract offer. If the contracting party accepts the offer/quote in writing/email/signature or during a site selection meeting, the contract for participation in the fair is concluded.

1.3 Space Allocation and Contracting

FIRST ALLOCATION

To participate in C&R 2025, you must submit the completed Participation Request and pay the indicated reservation fee. Companies that submit this documentation before February 21, 2025, will participate in the **first space allocation process**, which will take place in April 2025, optimizing their chances of selecting a preferred space. We will provide further information regarding the space selection criteria applied during this first allocation.

NEW PARTICIPATION REQUESTS

Space requests received after February 21, 2025, will be handled in the order they are received, based on the submission of the **Participation Request** and the corresponding reservation fee payment (the latter being a requirement that will determine the official request submission date). This will be processed in May 2025.

Space will be allocated after written acceptance by the exhibitor.

The exhibitor will receive the exhibition contract with the statement of accounts and stand plan(s) and will then be able to access the Expo Zone customer portal to manage their participation.

It is essential to make the payments indicated in the contract within the established deadlines.

1.4 Participation Options.

- **Exhibitor:** is the natural or legal person, which has space at the fair. The exhibiting company is the company in whose name the application to participate as an exhibitor is completed.

The exhibitor has the option of contracting a 'basic turnkey stand' or contracting only the space to build his own 'free design stand'.

- **Co-exhibitor:** Participating in the stand of a main exhibitor by contracting directly with them.

1.5. LIVE Connect: The Digital Platform Accessible with Your Exhibitor Plan

What will you find on LIVE Connect?

LIVE CONNECT is a digital ecosystem that **fosters connections with other professionals**, facilitates meeting preparations, offers exclusive content and activities, and generates business opportunities.

Business and networking

Identify leads to generate business and schedule high-value meetings.

Post-fair ecosystem

Activity and visibility after the fair: access and share content, participate in challenges, and much more.

Positioning

Highlight your company and increase the visibility of your offering.

What can I do from my Exhibitor Area in LIVE Connect?

- Update my company details visible in the web catalogue and in C&R LIVE Connect.
- Add my products and services, which will be visible in C&R LIVE Connect.
- Register team members so they can access the digital event C&R LIVE Connect.

What can I do during the digital event C&R LIVE Connect?

- Search for relevant contacts in the professional network
- Contact request for chatting and videoconference.
- Request and/or accept appointments for professional meetings at my stand at the fair or by videoconference.
- Complete my professional profile as a user of the platform and set my availability agenda of for meetings.
- Check out onsite and online activities and add them to your calendar.
- View information on what other exhibitors offer.
- Scan visitor passes at the fair.

Exhibitor Plan: Conecta

Participation as a regular exhibitor at the fair requires the **CONNECTA Plan** (Communication & Marketing Pack + LIVEConnect): **€453 + VAT (1)**.

This package includes:

- Promotion of participation through inclusion in the exhibitor list accessible on the ifema.es/en/cr website and shared as a link in sector communications.
- Presence as an exhibitor in the C&R LIVE Connect digital event. The digital event extends the fair's duration, offers additional content on the exhibitor offering and industry news, and is accessible to registered exhibitors and visitors.

- Presence during the fair on floor plans and exhibitor lists.
- Access to IFEMA Madrid's "EXPO ZONE" customer private area for managing participation.
- Exhibitor passes according to the contracted space (see point 2.3).
- Online invitations according to the contracted space (see point 2.3).
- Discount transport vouchers.
- Premium Wi-Fi connection for 3 users throughout the fair (these connections only work with devices compatible with the 5 GHz band). The password will be activated for the fair's duration and will be sent to the registered email address at least 48 hours before the event.

Functionalities for connecting with other users to generate business and networking opportunities:

- Search for new contacts among registered visitors and exhibitors.
- Communication with contacts (chat and videoconferencing)
- Preparation of meetings to optimise time at the trade fair
- Scanning of visitor passes at trade fairs

1. HOW TO PARTICIPATE

1.6 Your Space at the Fair. Stand Types

- **Basic Turnkey Stand:** Modular stand, aluminum structure in grey, melamine panels.
- **Custom Design Stand:** Only floor space. This option involves renting space only, and exhibitors must submit a stand construction project for IFEMA Madrid's approval.

Participating in the fair requires contracting the following general services:

- ❖ **Liability insurance** (coverage up to €60,000)(*)
- ❖ **Multifair insurance** (coverage up to €50,000)(*)
- ❖ **Minimum energy consumption** (0.13 kW/m²)(*)
- ❖ **Assembly rights** (service included with the Basic Turnkey Stand Basic Stand)(*)
 - **Type A:** Undecorated spaces, or spaces covered with carpet or platform.
 - **Type B:** Basic aluminum modular stands or similar.
 - **Type C:** Custom-designed modular stands, carpentry stands, and other materials.

❖ **Exhibitor Conecta Plan.**

(*) Services already included with the Basic Turnkey Stand.

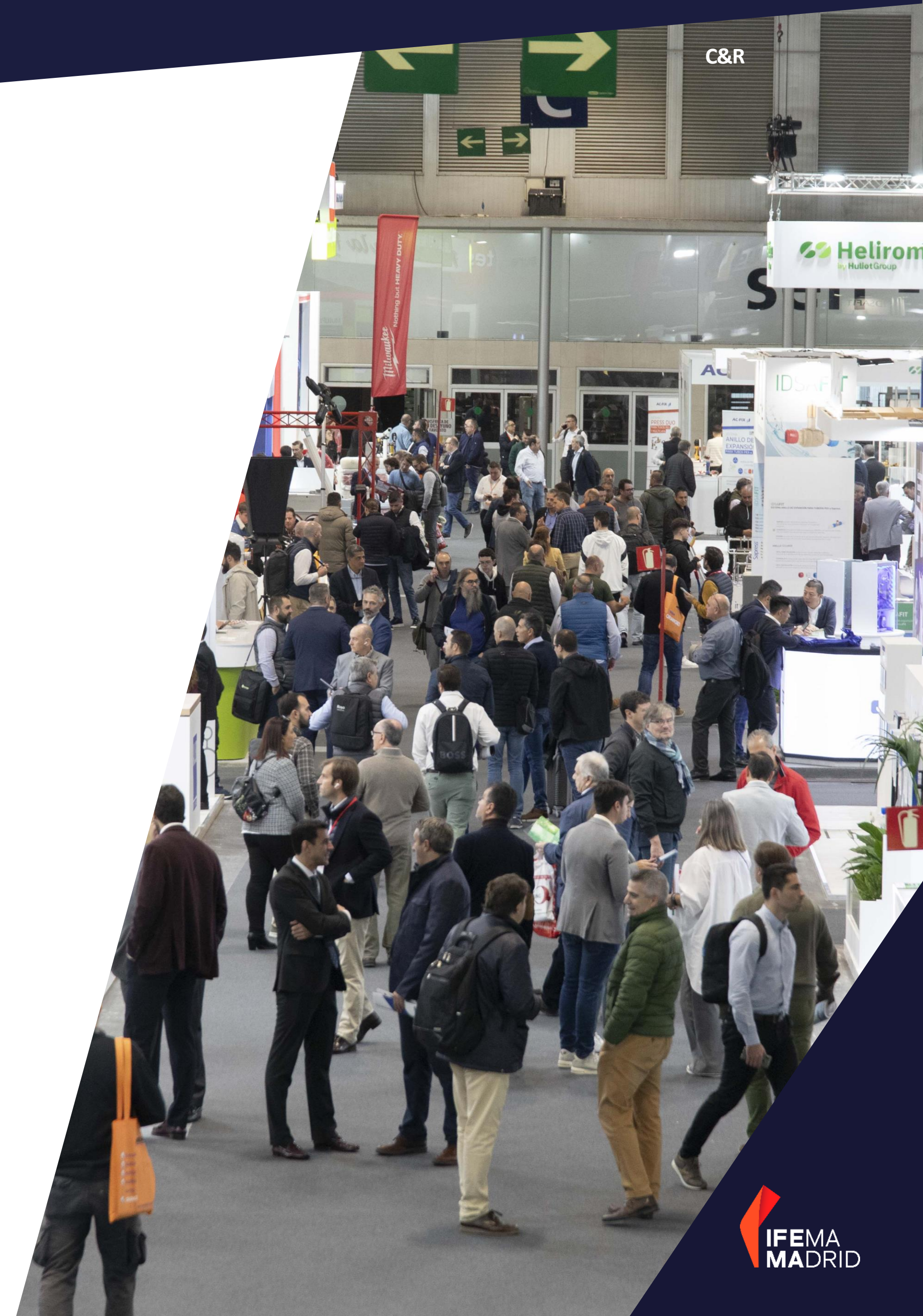

BASIC TURNKEY STAND

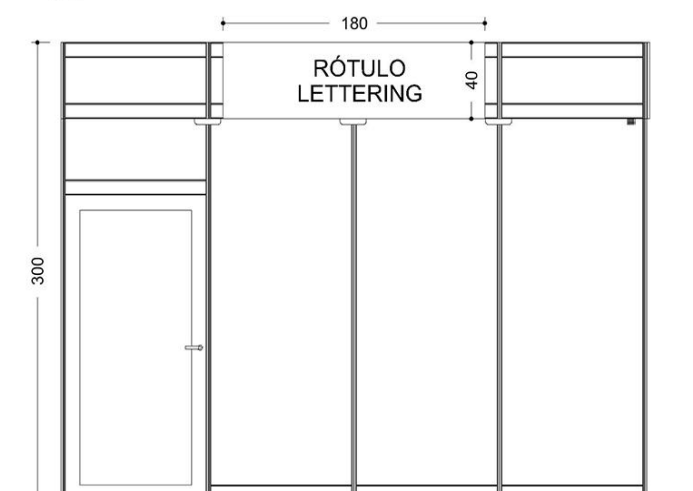

STAND

Stand opening to one or more aisles, depending on location.
Grey aluminum structure and melamine walls.

STORAGE ROOM with lockable door in the following proportion:

Up to 16 sq.m 1x1 m
From 16.5 to 32 sq.m 2x1 m
For 32.5 sq.m or larger 3x1 m

EXHIBITION CARPETING

5 colors to choose from in Expo Zone. Jasper Gray by default. The exhibitor must indicate the chosen carpet color by **October 28, 2025**.
If no color is indicated, jasper gray will be used by default.



ELECTRICITY AND LIGHTING

- Lighting by means of LED spotlights on rails at a rate of one spotlight per 3 sq.m of stand.
- Electrical panel with magnetothermal differential with a built-in 500W socket, suitable for 130W/sq.m power.

LETTERING

Standard lettering with name of exhibitor, which is editable in the EXPO ZONE, and stand number. **Maximum 20 characters**.
If the exhibitor's name field in the Expo Zone is not filled in, it will be labelled with the Trade Fair Name on the Participation Application Form. Must indicate the company name for the labeling, through your EXPO ZONE before **November 4, 2025**.

MANDATORY CONTRACTING

In addition, participation as an exhibitor implies the obligatory contracting of the CONNECT PLAN (formerly the Marketing and Communication pack): 453€ + VAT (1)

INCLUDED SERVICES

- Daily cleaning of the stand (Type A, once a day).
- Set-up fees included in the price.
- Multi-fair and civil liability insurance included in the price.
- Minimum electric power consumption (0.13 Kw /sq.m).

CLEANING TYPE A

First cleaning with removal of the plastic covering the carpet and daily cleaning of the floor and collection of the contents of the wastepaper bins. Cleaning of the exhibited elements is not included.

ASSEMBLY PLAN

Your assembly plan can be viewed in the EXPO ZONE with the location of the warehouse and other services included. In addition, you can track the status of the plan and make comments on it, in case you need to make any changes.

ADDITIONAL SERVICES

Customize your modular stand with our Stand Graphic Decoration service decoraciongrafica@ifema.es

INDICATIVE DRAWING. Drilling is not allowed. It shall be adapted to the dimensions of the space allotted.

OBSERVACIONES: • All services or modifications that you wish to add or make, parting from these basic features shall be at your expense. • We shall try to adapt the layout of the elements that form the stand, the additional ones as well as the structural ones that are necessary for the support of the stand as much as possible to the exhibitor's needs, if it is technically possible and the plan is received with the pertinent instructions at the latest fifteen days before the beginning of the assembling period. • Once the stand has been assembled, changes in the location of any of the elements previously described, and of which the Management has not been notified, shall be billed. • The elimination, by the exhibitor, of any element of the prefabricated stand shall not mean a reduction in its cost. • All material you may use, both structural or electrical, is rented, and therefore, any deterioration in it shall be billed at current rates.

Turnkey Stand Regulations

All modular stands that include interior decoration elements such as panels, profiles, totems, platforms, trusses, etc., **MUST UPDATE their project in the EXPO ZONE no later than October 12, 2025.**

The removal or substitution of any modular stand element by the exhibitor does not imply a reduction in cost. All materials used, both structural and electrical, are rented, and any damage will be charged according to the current rates.

The layout of all stand components, requested extras, as well as any structural elements required for the stand's support, will be adapted to the exhibitor's needs whenever technically feasible and provided that the plan with the relevant instructions is UPLOADED TO THE EXPO ZONE at least 1 month before the start of assembly: October 12, 2025.

Personalize Your Stand with Us: Graphic Decoration for Stands

Customize your modular stand with your brand's image to create the maximum impact on visitors. We offer a wide range of graphic materials (vinyl, foam, Forex, banners, etc.), versatile and adaptable to all elements of your stand, including walls, furniture, fascia, banners, and displays.

Request more information and a quote by contacting decoraciongrafica@ifema.es. Our specialized team will handle production and installation.

Please note that after the stand assembly is complete, any changes to the placement of elements that were not communicated by the established deadline will incur additional charges.

Custom Stand Design - Stand Assembly

Companies choosing to design and build custom stands **must UPLOAD their project** for approval in the **EXPO ZONE before October 12, 2025. If your project includes rigging structures, you must send a specific project to inspeccion.rigging@ifema.es by the same deadline, October 12, 2025.**

The company responsible for assembling a custom-designed stand must pay the corresponding assembly rights to IFEMA MADRID before beginning the installation. These fees cover the services provided during the fair's setup and dismantling periods. If the main exhibitor prefers to handle this payment directly, it can be included in their invoice by contracting it via the Expo Zone.

For safety reasons, and as a general and permanent preventive measure due to the concurrence of activities, it is permanent preventive measure due to the concurrence of activities, it is compulsory to wear a protective helmet, high visibility vest and helmet, high visibility waistcoat and safety footwear during the assembly and dismantling phases of the assembly and dismantling phases of fairs and events in all exhibition areas.

Assembly rights

In order to be more efficient and to be able to provide you with a better service, IFEMA MADRID has started to apply a last minute surcharge to the contracting of assembly rights, as is the case with the rest of our services.

This surcharge increases the price by 25% when the contract is made during the week prior (7 days before) to the start of the assembly, during the assembly, celebration and dismantling.

We remind you that the assembly fees apply to free design assemblies and can be contracted can be booked with a 5% discount if booked up to 30 days before the start of the assembly.

To contract services, you must go through our online channel, which you can access from the following link: [Commerce](#).

Companies opting for the free construction of their stands must SUBMIT THEIR EXPO ZONE the project for approval **before 12 October 2025.**

FREE-DESIGN STANDS

Segunda planta.
Máxima ocupación segunda planta.

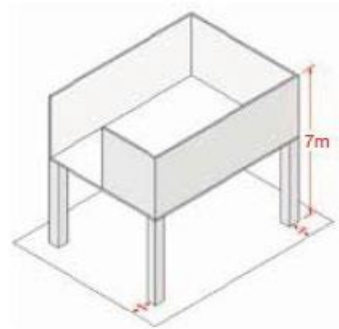

Normativa de alturas.
Máxima ocupación espacial a ocupar con cualquier elemento.

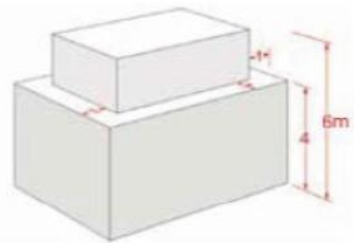

Cerramientos.

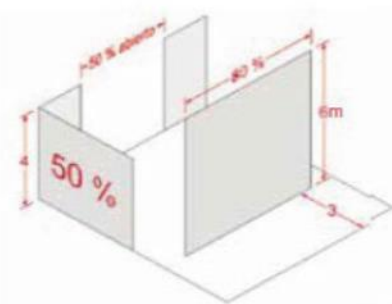

SPECIFIC ASSEMBLY RULES FOR FREE-DESIGN STANDS

Height

- Maximum authorised height within the perimeter line. 4 m
- In order to raise or hang any decorative element to a maximum height of 6 m, a 1 m margin must be left within the inside of the perimeter of the whole stand.
- This possibility does not exist in the connecting nuclei between halls, nor on the entrance sides of Halls 9 and 10.
- Building elements, decoration and spotlights may not protrude more than 50 cm from the allotted space and from a minimum height of 2.5 m.

Blind perimeter walls in the perimeter environment

- Blind perimeter walls cannot make up more than 50% of each side facing an aisle.
- Longer walls must be set back at least 3 m from the perimeter and cannot make up more than 80% of the length of the façade.

Second Floor

- The maximum permitted height for two-storey stands is 7 m in the halls.
- The second floor must be set back 1 m within the entire perimeter of the stand.
- It is not permitted to build a second floor in the connecting nuclei between the halls and in the side entrance areas to Halls 9 and 10.
- They must present a certificate specifying the dimensions, the load of use and the seating capacity, it being the sole responsibility of the exhibitor to comply with the limits established therein.

The interpretation and application of the regulations for each individual case is the responsibility of IFEMA MADRID, which reserves the right to arbitrate on exceptions, if it deems necessary, on the basis of respect for the general appearance of the Fair and the visibility of neighbouring stands.

DESING YOUR STAND WITH US

In addition to turnkey stands, we offer a comprehensive stand design service tailored to your specific needs, with our full guarantee. We handle everything— from space planning and design to assembly and dismantling. Request a customized project free of charge and without obligation by emailing infodesign@ifema.es.

1.7 Participation fees

Type of Space	Rate
Floor space only: from 16.00 to 50.00 m2	173.20€/m ² + VAT(1)
Floor space only: from 50.50 to 100.00 m2	164,90€/m2 + VAT(1)
Floor space only: from 100.50 to 250.00 m2	156,20€/m2 + VAT(1)
Floor space only: from 250.50 to 400.00 m2	126,30€/m2 + VAT(1)
Floor space only: from 400.00 m2	113,70€/m2 + VAT(1)
Turnkey stand 16.00 m2	3.949,50€ + VAT(1)
Additional m2 turnkey stand	227,60€/m2 + VAT(1)
Second floor	75,70€/m2 + VAT(1)
Outdoor space	88,00€/m2 + VAT(1)
Aisle space	37,85€/m2 + VAT(1)

SERVICES	RATE
Civil liability insurance (covers up to €60,000)	72,84€ + VAT(1)
Multi-fair insurance (covers up to €50,000)	69,15€ + VAT(1)
Minimum electricity consumption (0.13 kW/m ²)	7,43€ + VAT(1)

Assembly Fees	
Type A: undecorated spaces or covered with carpet or platform	2,77€/m ² + VAT(1)
Type B: basic modular stands in aluminum or similar	5,56€/m ² + VAT(1)
Type C: custom-designed modular stands in aluminum, carpentry, and other materials	8,75€/m ² + VAT(1)

CONNECTA PLAN	453€ + VAT(1)
Co-exhibitor fee	453,00€ + VAT(1)
Additional exhibitor passes	6€/ud. + VAT(1)
VIP Passes	50€/ud. + VAT(1)
Innovation Gallery	770€ + VAT(1)

1.8 Deadlines and payment

Discounts:

5% DISCOUNT ON SERVICES CONTRACTED THROUGH THE EXPO ZONE, UP TO 30 DAYS BEFORE STARTING ASSEMBLY.

This discount will also be applicable to services contracted by sending your stand plan to the technical secretariat. This does not include the minimum obligatory services, external advertising, meeting rooms, graphic decoration of stands or specific fair services such as exhibitor passes, invitations, etc

Surcharges:

25% increase for hiring of assembly rights requested 7 days before the start of the assembly (5 November 2025).

DATES FOR MAKING PAYMENTS

- **When submitting the Participation Application Form**, the space reservation fee will be paid, according to the following rates:
 - From 16 to 50 m2:450€ + VAT (1)
 - From 50.5 to 100 m2:750€ + VAT (1)
 - From 100.5 m2 upwards:1,500€ + VAT (1)

- **25 July 2025:** deadline for payment of the first 50% of the contracted space, minus the space reservation fee.
- **13 October 2025:** deadline for payment of 100% of the contracted space and services.

You can pay in the following ways:

- ❖ Transfer to: IFEMA MADRID / C&R 2025.

Santander: IBAN ES64 0049 2222 5115 1000 1900 SWIFT: BSCHESMM
 BBVA: IBAN ES89 0182 2370 4000 1429 1351 SWIFT: BBVAESMM
 Caixa Bank: IBAN ES93 2100 2220 1102 0020 2452 SWIFT: CAIXESBBXXX
Send a copy of the bank receipt to servifema@ifema.es

- ❖ Certified cheque made out to IFEMA MADRID/C&R 2025.
- ❖ Credit card in a secure environment, accessible after completing the participation application online, or subsequently in the EXPO ZONE. In accordance with current regulations, payments in cash or bearer cheques are not accepted.

In the Expo Zone you will find your trade fair participation statement of accounts and invoices after payments have been made. If you need an invoice for payment, please request it by email to servifema@ifema.es

(1) Companies based in Spain (excluding the Canary Islands, Ceuta and Melilla): 10% VAT not included. For other companies this operation is not subject to Spanish VAT. For companies based in the European Union, the exhibitor shall be liable to VAT and may, if applicable, claim it back in the country where the company is domiciled.

1.9 Specific fair regulations

The minimum space for booking is 16m².

All companies are required to set up their stand, which must include, at a minimum, partition walls with the pavilion wall and neighboring stands, depending on the location.

In cases where only the floor space is rented (custom-designed stands), the company responsible for assembling the stand must pay IFEMA MADRID, before the assembly work begins the corresponding assembly rights fees for the services provided during the fair's assembly and dismantling period. If the exhibitor wishes to assume this fee and have it included in their invoice, they must arrange this in their EXPO ZONE.

The event management reserves the right to modify the assigned spaces or make changes to the layout of the pavilions for organizational reasons.

Without prejudice to the C&R Management informing exhibitors in the event of relocation or significant alteration of the reserved location, each exhibitor is obliged to inform himself of the location of his stand, its exact dimensions, etc.

Any exhibitor who has not paid the full fee for the space booked as well as any costs for services requested, shall not be permitted to either occupy the stand space or have the modular stand delivered.

Access will not be granted to any exhibitor or visitor who cannot prove they belong to the participating professional groups, even if they hold the relevant pass or invitation.

The exhibitor must not leave their stand unattended and must remain with the products on display throughout the entire period and opening hours of the exhibition. Non-compliance with this regulation could mean losing the right to preferential renewal of the allocated space.

The direct sale of goods is strictly forbidden.

Exhibitors authorise IFEMA MADRID to reproduce all or part of their stand and the products, services and activities carried out therein.

The exhibitor undertakes to comply with the rules and guidelines for protecting the environment.

Activities that may disturb other exhibitors are prohibited, and noise levels must not exceed 60 decibels.

Promotional activities, distribution, and display of samples, brochures, flyers, and all promotional materials must take place exclusively within each exhibitor's designated space.

If catering services are required during the C&R event, the exhibitor must fill out the "Notification for catering at stands" form available at ifema.es and send it to catering@ifema.es.

Exhibitors are expressly forbidden from setting up Wi-Fi access points for Internet connections or other functionalities. This measure is to avoid interference with independently installed Wi-Fi points and IFEMA MADRID's access points. Such interference could cause Wi-Fi networks to malfunction. For more information, see Article 33 of the General Regulations for Exhibitor Participation in Events Organized by IFEMA MADRID.

These Specific Regulations are complemented by the General Regulations for Exhibitor Participation in Events Organized by IFEMA MADRID, which all exhibitors accept by participating.

1.9 Specific fair regulations

CONFIRMATION OF SPACE

Once a proposal for a location and area has been accepted, the Application for participation constitutes a non-revocable commitment by the applicant.

Once the final details of the application have been agreed upon, the exhibitor will receive from the Show Management the corresponding Exhibition Contract with the statement of accounts and plan of the location and dimensions of the stand/s, as well as all the information on the services offered by IFEMA which will allow you to make the most of your presence at the fair.

It is essential to make the payments indicated in the application form within the established deadlines.

CANCELLATION

The exhibitor's withdrawal from participating in the event will result in the termination of the contractual relationship between IFEMA MADRID and the exhibitor. The withdrawal must be communicated in writing to the Event Management and will result in the loss of any amounts due at the time of notification, in accordance with the payment schedule outlined in the Application form.

If the withdrawal is communicated within 30 days prior to the event's opening, IFEMA MADRID may require full payment for the contracted space.

For additional services offered by IFEMA MADRID that were contracted before the withdrawal notification, the cancellation fees outlined in Article 7 of the general terms of admission and contracting in events organized by IFEMA MADRID will apply.

In the event of fair cancellation due to force majeure, any payments related to in-person participation will be refunded, as per Article 15 of the **General Participation Rules** in events organized by IFEMA MADRID.

ASSEMBLY AND DISMANTLING

The **assembly of custom-designed stands** may take place from **November 12 to 16, 2025**, during the following hours:

- November 12 to 14, from 8:30 a.m. to 9:30 p.m.
- November 15 and 16, from 8:30 a.m. to 7:30 p.m.

The delivery of modular stands contracted with IFEMA MADRID **will occur on November 17, starting at 8:30 a.m.**

The **delivery of goods and decoration materials** may take place **on November 17, from 8:30 a.m. to 9:30 p.m. From 7:00 p.m. onward, entry will only be allowed through pedestrian doors**, as the goods gates will be closed to allow for the installation of recyclable carpet.

Exhibitors will not be allowed to occupy their space or receive their modular stand, if applicable, unless full payment has been made for the contracted space and requested services.

For issues related to exhibitor passes, accreditation desks will be available at the South and North gates from November 17 to 20, between 9:30 a.m. and 7:30 p.m.

The removal of goods and decoration materials may take place **on November 20, from 7:30 p.m. to midnight. From 7:30 p.m. to 8:30 p.m., only pedestrian exits will be used to allow** for the removal of the recyclable carpet. After that, the goods gates will open until midnight.

Dismantling of the stands can take place on:

-Halls 5 and 9: 21, 22 and 23 November 2025

-Hall 7: 21 and 22 November.

On **21 November** from **8:30 am to 9:30 pm** and on **22 and 23 November 2025** from **8:30 am to 7:30 pm.**

1.9 Specific fair regulations

GENERAL ASSEMBLY RULES

All companies must assemble their stand, which must include, at a minimum, partition walls with the pavilion wall and adjacent stands, depending on the location.

For **safety** reasons, and as a general and permanent preventive measure due to the simultaneous activities, **the wearing of protective helmets, high-visibility vests, and safety shoes is mandatory during the assembly and dismantling phases of fairs and events in all exhibition areas.**

During the assembly, no passes are required, and there are no assembly passes.

Assembly work cannot begin until the "Occupational Risk Prevention and Business Activity Coordination" protocol has been completed and sent to IFEMA. This document is available on the IFEMA MADRID website (ifema.es –Exhibitors – Participation Rules –Forms, Article 15 of the General Participation Rules for Exhibitors in Events Organized by IFEMA MADRID).

Vehicle Circulation and Parking Rules During the Event:

Parking vehicles in loading and unloading areas within the fairgrounds is expressly prohibited. Vehicles may only park in designated areas and, where applicable, pay the corresponding fee. Once the event has opened, no vehicles may circulate within the pavilions or on the avenue, except with express authorization from IFEMA MADRID (Article 14 of the General Participation Rules of IFEMA MADRID).

Installation of Recyclable Carpet in Common Areas:

In line with IFEMA MADRID's commitment to the 2030 SDGs (Sustainable Development Goals of the United Nations), as outlined in **the Sustainable Participation in Fairs and Events Guide**, and to optimize the process of installing and removing recyclable fair carpet for its subsequent reuse, goods entry and exit times must align with these processes. We appreciate your cooperation with our environmental commitment.

IFEMA MADRID carpets the aisles during the fair using standard-sized, reusable strips. Consequently, a small strip at the edge of the aisle next to the stands may remain uncarpeted. **These uncarpeted strips are part of the aisle, not the stands, and therefore exhibitors are not permitted to cover or decorate them.** We ask exhibitors to respect this decision. IFEMA MADRID staff will monitor compliance and request that any carpet invading these strips be removed. If the strip is encroached despite controls, **the space will be charged to the exhibitor as aisle space.**

Waste Management and Assembly/Exhibition Materials:

All companies participating in the assembly and dismantling of stands must manage their waste and ensure its removal within the established deadlines. IFEMA MADRID offers the option of renting containers to facilitate waste sorting and removal and will oversee the process (see prices in the Customer Portal Expo Zone, under Service Contracts, in the Cleaning and Waste Containers section).

Exhibitors forfeit any right to claim for lost or damaged materials that remain in the exhibition area after the deadline and will bear the costs for their removal, which IFEMA MADRID will invoice according to established rates (see Article 35 of the General Participation Rules for Exhibitors in Events Organized by IFEMA MADRID).

SPECIAL AUTHORIZATIONS

On the ifema.es website, you will find a list of other services, regulations, and forms that may be of interest, including:

- Notification for catering services at stands.
- Occupational risk prevention and business activity coordination.
- Private security authorization request for stands.
- Wi-Fi installation authorization request.
- Antenna cabling authorization request.
- Request for rigging authorization.

<https://www.ifema.es/en/support/exhibitors-ifema-fairgrounds>

1. HOW TO PARTICIPATE

1.10. Exhibitor calendar

When	What	How	Who attends to you
Until February 21, 2025	Application for participation (priority deadline for space selection)	Filling in the online Application for Participation form and send a copy of the space reservation payment to: servifema@ifema.es to be able to participate in the first allocation space.	Event management: cr@ifema.es Customer Service (Exhibitors): (+34) 917223000 atencionalcliente@ifema.es
From February 21, 2025	Application for participation	<ul style="list-style-type: none"> - Continuation of the process of receiving applications for participation. - Offers from in April, confirmation of space and sending of contracts. 	Event management: cr@ifema.es Customer Service (Exhibitors): (+34) 917223000 atencionalcliente@ifema.es
Until 25 July 2025 Until 13 October 2025	Payments	<ul style="list-style-type: none"> - Until 25 July 2025 - 50% of the amount of the space minus the reservation fee. - Until 13 October 2025 - 100% of the amount of the space and services booked. 	Servifema: servifema@ifema.es Customer Service (Exhibitors): (+34) 91 722 30 00 atencionalcliente@ifema.es
Until 12 October 2025	Free-design projects	Deadline for uploading free-design projects to the EXPO ZONE. If the project has hanging elements they need be submitted in a separate project and sent to: inspeccion.rigging@ifema.es	Technical Office IFEMA MADRID Line Exhibitors (+34) 91 722 30 00 atencionalcliente@ifema.es
Until 12 October 2025	Customisation of modular stands	<ul style="list-style-type: none"> -Submit projects for the interior decoration of modular stands. -Last day to choose the colour of the carpet via the Expo Zone: 2 WEEKS BEFORE STAND ASSEMBLY BEGINS (28 October 2025). -Last day to complete your stand lettering in the Expo Zone: 1 WEEK BEFORE STAND START OF ASSEMBLY (4 November 2025). -Deadline to modify the partial plan of your stand through Zona Expo indicating the location of the walls, coat rack, shelves, furniture, etc.: 1 MONTH BEFORE STAND ASSEMBLY BEGINS (12 October 2025). -You will have to consult the modular stand project at ZONA EXPO, or upload the same with the stipulated modifications. 	Secretaría Técnica Línea IFEMA MADRID Expositores (+34) 917223000 atencionalcliente@ifema.es

1.10. Exhibitor calendar

When	What	How	Who attends to you
Until 13 October 2025	Booking services	Services booked with a 5% discount.	IFEMA MADRID Line Exhibitors (+34)91 722 30 00 atencionalcliente@ifema.es
From 5 November 2025	Booking services	25% increase on prices for last minute contracting of assembly rights and all other services.	IFEMA MADRID Line Exhibitors (+34)91 722 30 00 atencionalcliente@ifema.es
From 12 to 16 November 2025	Stands set-up	- From 12 to 14 November from 8.30am to 9.30pm. - 15 and 16 November from 8.30am to 7.30pm.	-
17 November 2025	Delivery of modular stands	From 8.30pm	Hall manager
	Incoming merchandise	- From 8.30am to 9.30pm - From 7pm onwards, entry will only be possible through the pedestrian gates, as the goods entrances will be closed in order to proceed with the installation of recyclable carpeting.	Hall manager
From 18 to 20 November 2025	Days of the trade fair	- From 18 to 20 November: from 10.00am to 7.00pm	-
20 November 2025	Outgoing merchandise	From 7:30 pm to 00:00h. From 7:30pm to 8:30pm, exit will only be possible through the pedestrian gates for the removal of recyclable carpet. After this time, the goods gates will be open until 00:00h.	Hall manager
21, 22 and 23 November 2025	Dismantling of stands	21 November from 8.30 am to 9.30 pm; 22 and 23 November from 8.30 am to 7.30 pm.	Hall manager

2.1 Expo Zone. Manage your participation and space. Additional services contracting. E-commerce

Access our customer area Expo Zone from the website: <https://www.ifema.es/en/cr> to manage your company details, contacts, and everything related to your participation. You will be able to access your participation details once it is confirmed with the user account (email used to complete the application).

What can I do in Zona Expo?

- Access details of each participation, floor plans, and projects.
- Access the exhibitor's calendar.
- View documents of interest.
- Manage exhibitor passes and request visa support letters.
- Download discount vouchers: Renfe, Iberia, Iryo.
- Send invitations.
- Register co-exhibitors.
- Access orders, payments, account statements and invoices issued
- Upload free design stand projects
- Request the distribution of modular stand elements, such as coat racks or shelves, add the sign, and choose the carpet color.
- Access e-commerce for contracting services.

2.2 Registration of co-exhibitors

The registration of co-exhibitors must be done by the exhibitor from the EXPO ZONE section Manage your participation/Register co-exhibitors.

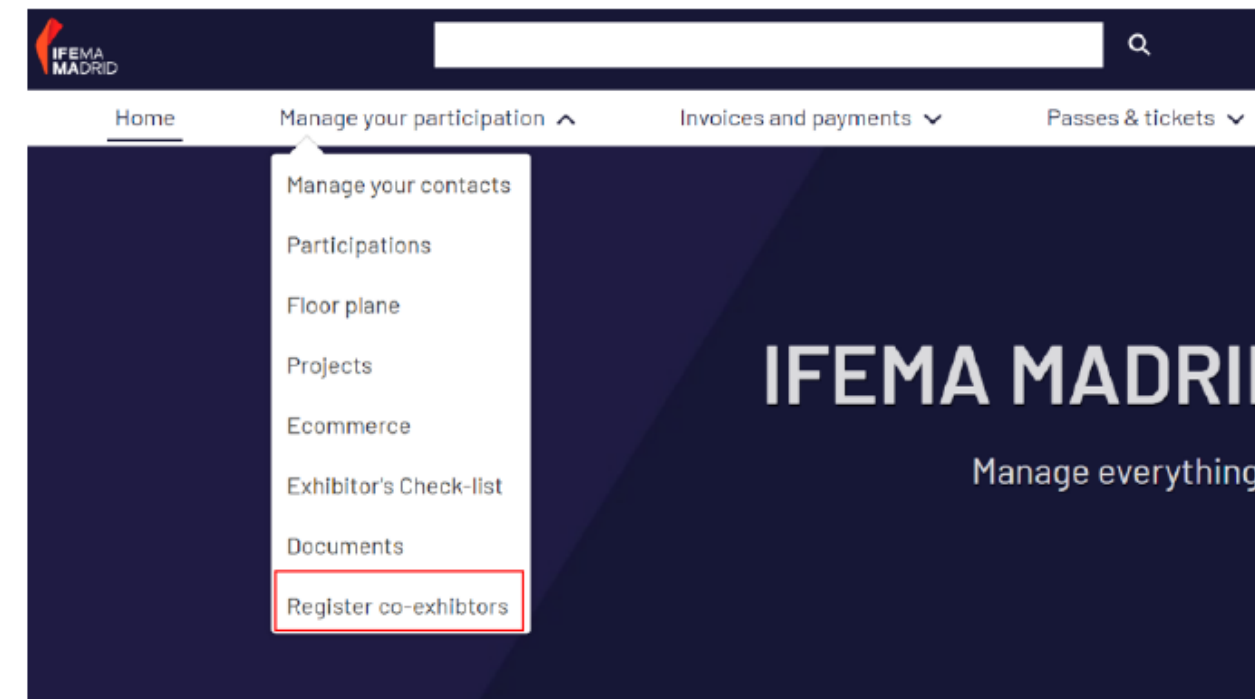

To register, it is essential to enter a correct and unique e-mail address for each co-exhibitor and to indicate whether the participation fee (CONNECTA Plan) will be paid by the exhibitor or by the co-exhibitor.

Co-exhibitor must purchase the items included in the CONECTA Plan (Marketing & Communication + LIVE Connect pack):

Co-exhibitor registration fee 453,00€ + VAT (1)

(1) Companies based in Spain (excluding the Canary Islands, Ceuta and Melilla): 10% VAT not included. For other companies this operation is not subject to Spanish VAT. For companies based in the European Union, the exhibitor shall be liable to VAT and may, if applicable, claim it back in the country where the company is domiciled.

Once this process has been completed, the co-exhibitor will receive a unique code to be included in their application form*.

***If the exhibitor assumes the cost of participation of the co-exhibitor, their registration will be confirmed by sending the participation application form (mandatory requirement).**

***If the co-exhibiting company assumes their own cost of participation, their registration will be confirmed by sending the participation application form and paying the corresponding amount.**

Each registered co-exhibitor will benefit from:

- ♦ Access to C&R LIVEConnect.
- ♦ Presence in the online exhibitor catalogue. Visibility in the official list of exhibitors accessible at: <https://www.ifema.es/en/cr>
- ♦ Access to their own EXPO ZONE.
- ♦ 2 Exhibitor passes.
- ♦ Online invitations.

2. MANAGE YOUR PARTICIPATION

2.3 Exhibitor passes and invitations. Visas. Vouchers and discounts

EXHIBITOR PASSES

Exhibitor passes will be managed from the **EXPO ZONE**, in the section "Event Access/Exhibitor Passes".

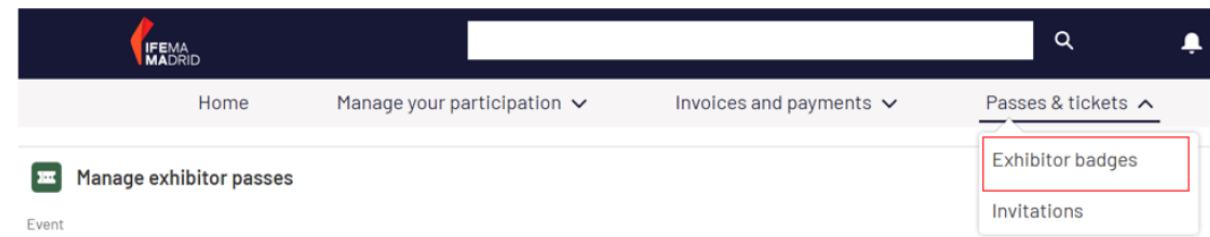

Each exhibitor will be allocated the passes corresponding to the contracted surface area (6 passes for stands of up to 50.00 m2 and 1 pass for each additional 10.00 m2 up to a maximum of 30 passes).

In order to ensure the professional nature of the fair, all exhibitor and co-exhibitor passes will be personalised: they will include the name of the pass holder, company and country. To prevent misuse, identity checks may be carried out at the entrances to C&R.

Exhibitors may **purchase additional exhibitor passes (6€/ud. + VAT) via the EXPO ZONE** section Event Access/Exhibitor Passes.

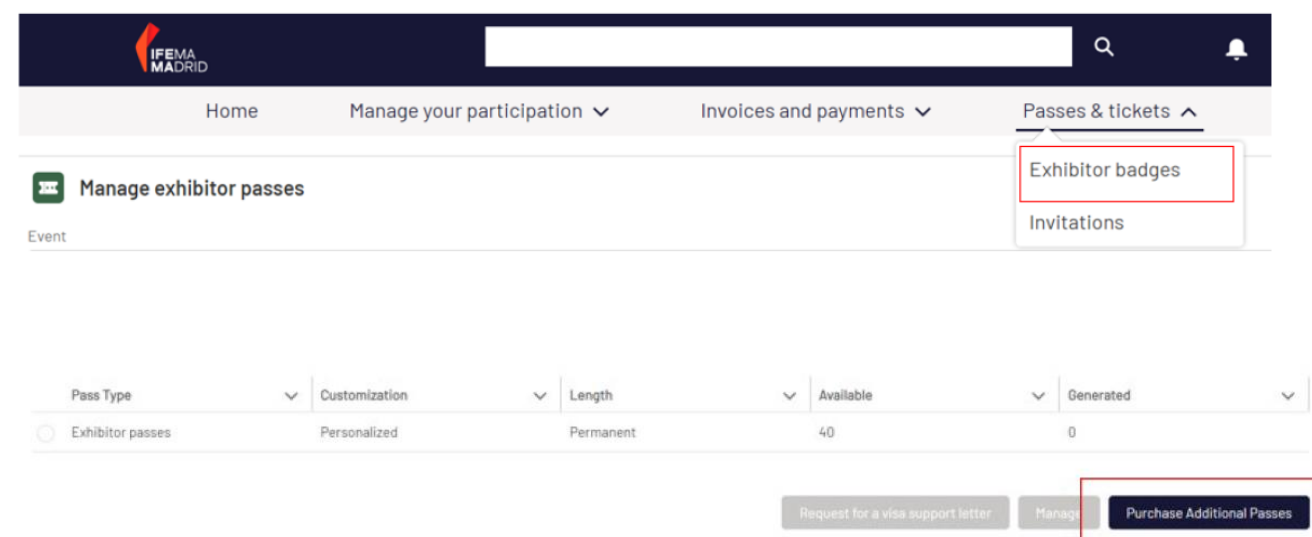

CO-EXHIBITOR PASSES

The co-exhibitor must manage their 2 exhibitor passes in the EXPO ZONE:

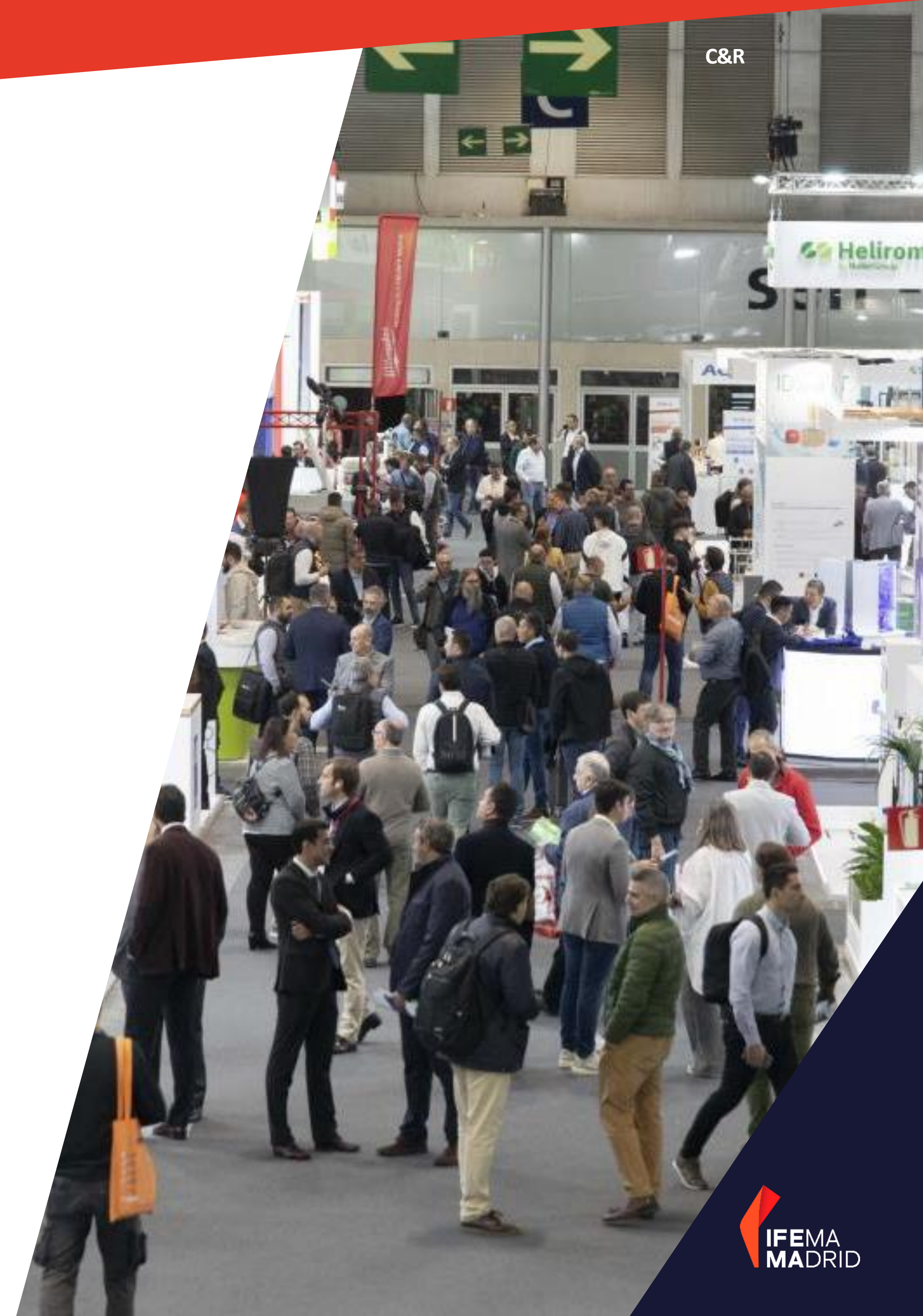
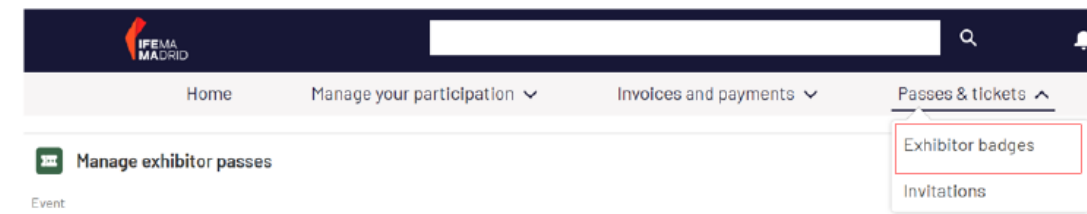

C&R

2. MANAGE YOUR PARTICIPATION

ON-LINE INVITATIONS

Each exhibitor will be issued on-line invitations to send to their contacts.

Exhibitors may purchase additional invitations by sending an email cr@ifema.es to the event requesting the exact.

Online registration will be open until 20 November 2025.

Exhibitors with a contracted area of more than 100m2 will be entitled to one VIP invitation for every 10m2 of contracted surface area.

They will be able to purchase VIP invitations for 50€ /unit.+VAT

Invitations will be sent via the "EXPO ZONE/Event access/Invitations/Manage invitations".

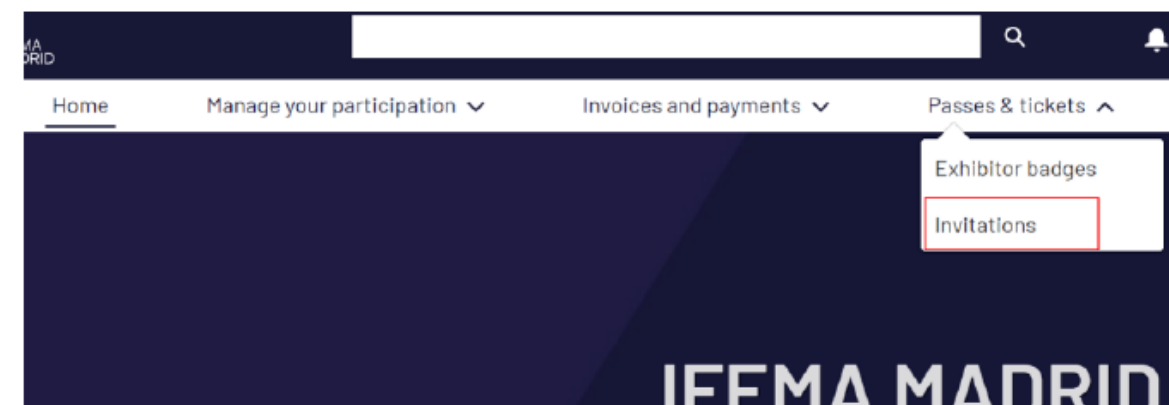

Following screen will appear for you to customise the sending:

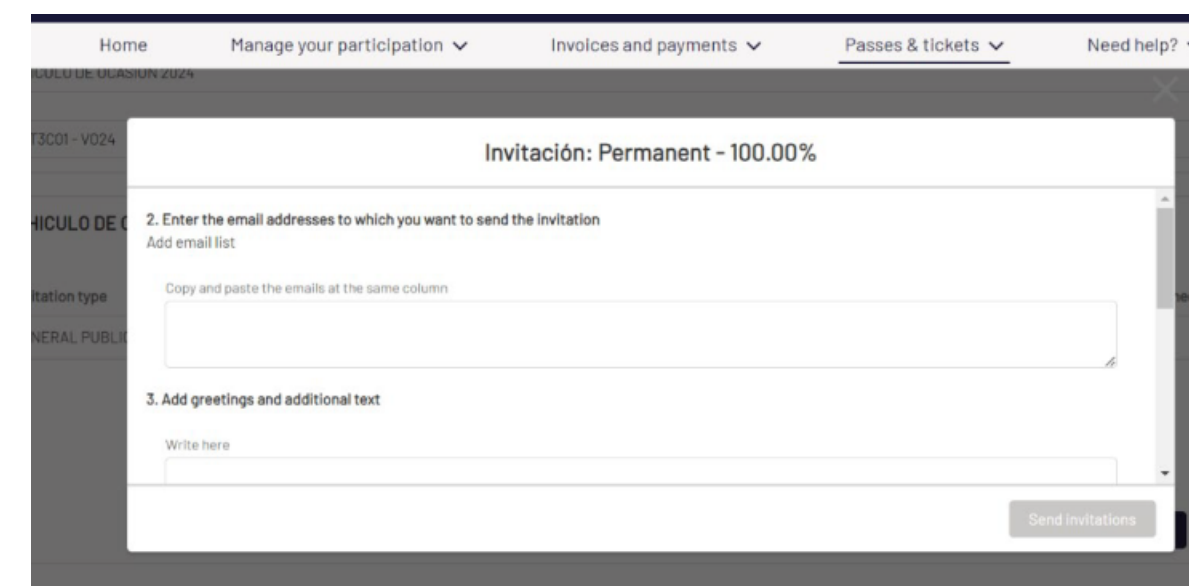

Exhibitors are urged to make good use of the invitations, sending them exclusively to professionals from the sector in order to guarantee the professionalism of the trade fair . Access controls may be carried out for this purpose.

Those who receive the **invitation code must register ONLINE** through the C&R website, ifema.es/cr in the section Purchase your pass, and entering the invitation code received to obtain their free pass to access the fair. (Invitation codes cannot be redeemed at the reception desk.)

It will be strictly required for all trade visitors who are going to enter the venue with a trade visitor invitation to be accredited as trade visitors through <https://www.ifema.es/en/cr>

VISA MANAGEMENT

If you require a travel visa, **you can request supporting letters to manage it via the EXPO ZONE.** To do so, **you must first personalise your exhibitor pass and have made payment** for your participation in accordance with the payment schedule (see point 1.8).

Once these two requirements have been met, via the EXPO ZONE/Event access/Exhibitor Passes section you will have access to the button Request Visa Support Letter.

We recommend start the process as soon as possible, as the deadline for visa applications is usually at least 30 days before travelling.

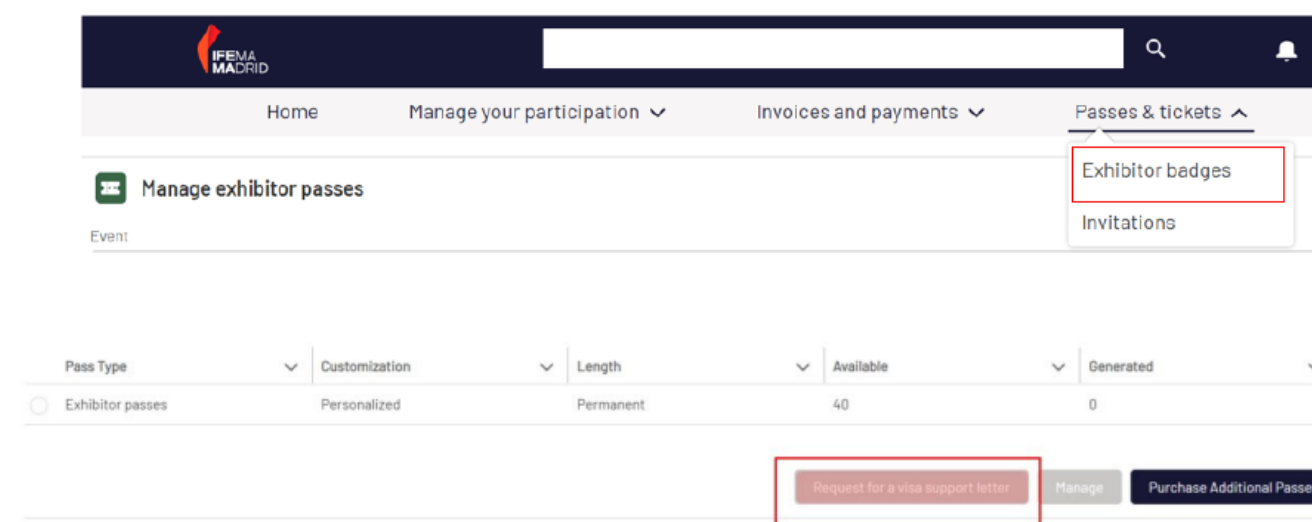

TRANSPORT DISCOUNT VOUCHERS

Once the exhibitor passes have been requested, the **corresponding transport discount vouchers can be downloaded from the EXPO ZONE** in the section Manage your participation/Documents.

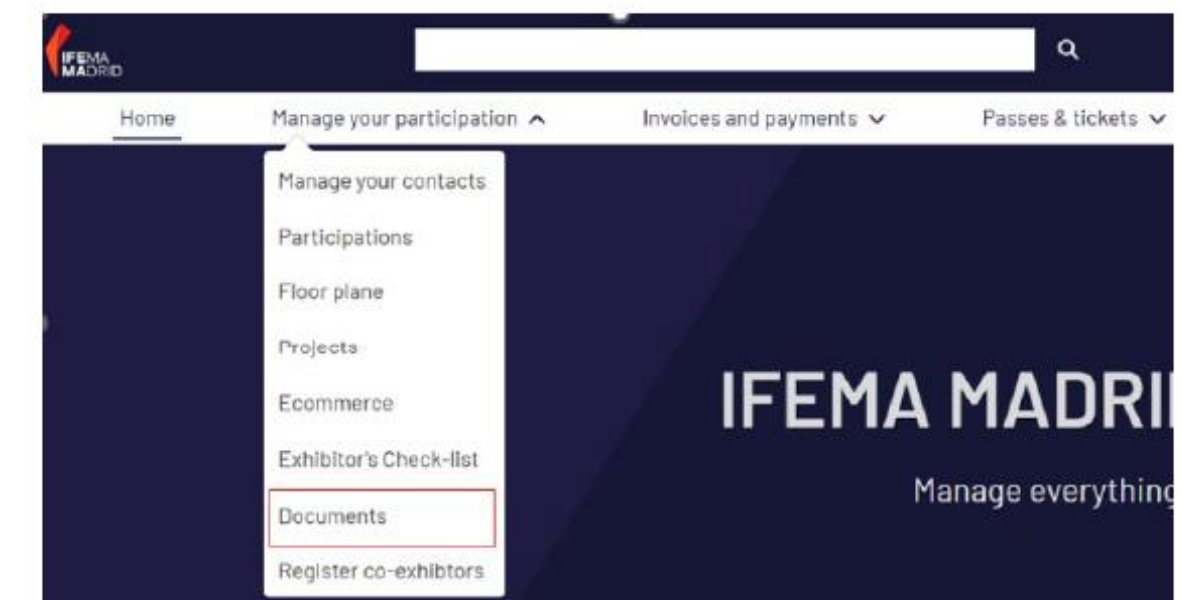

2.4 Other relevant information

DELIVERY OF MERCHANDISE TO THE TRADE FAIR CENTRE. CUSTOMS REGULATIONS

IFEMA MADRID staff are not authorised to receive any goods intended for your booth.

In order to send goods to the site, exhibitors must specify the following on the delivery address:

- IFEMA MADRID (Avda. del Partenón, 5. 28042 Madrid. Spain)
- C&R Fair
- Name of your company.
- Hall and booth number.

The goods must be received by your company's staff at your booth and must arrive during the days designated for the entry of goods and decorative material.

If it is not possible to comply with the above, we recommend you to contact our partner company for goods management (handling and storage):

DB Schenker Office at Recinto Ferial de IFEMA MADRID: Hall 7

Tel.: +34 91 330 51 77

ifema.madrid@dbschenker.com

CUSTOM REGULATION

1. All products coming from non-EU countries must go through customs procedures, with special mention to the fact that, since 1 January 2020, the United Kingdom has been treated as a third country, so all shipments originating from the United Kingdom must regularise their merchandise through the corresponding customs procedure.

2. Exhibiting companies must have the details of the customs agent clearing their goods or, failing this, a copy of the customs documentation for entry into the European Union.

3. The material or merchandise for distribution or consumption is subject to Spanish taxes, even if they are products with no commercial value (depending on the country, the amount of taxes may vary).

4. All goods subject to a temporary regime must not be moved from the stand or leave the IFEMA MADRID trade fair centre until their situation has changed and customs formalities have been completed. It may only be deposited during these formalities in the warehouse of the official logistics agent within the trade fair centre.

5. It is strictly forbidden to sell or distribute non-Community goods at a trade fair before customs clearance has been completed.

6. Products transported as hand luggage must be declared at Barajas Airport in the RED CHANNEL ("Something to declare") and the goods must be cleared with the corresponding authority at the airport.

7. Goods that have not passed customs control and are on display will be confiscated by the customs authorities operating at the Trade Fair Centre until the appropriate documents are presented.

8. Any lorry arriving at IFEMA MADRID under a transit consigned to IFEMA MADRID, must go to the warehouse of the official Logistics Operator, for the regularisation of the transported goods, located at:

Avenida Partenón s/n

Entrada Oeste – acces on Calle Rivera del Sena

Pabellón de servicios nave 2

28042 Madrid

In order to avoid undesired incidents, and for any questions you may have, please contact our Customs Operator, DB SCHENKER: (+34) 91 330 51 77: email: ifema.madrid@dbschenker.com

2. MANAGE YOUR PARTICIPATION

C&R

2.5. Map



2.6. FAQ's

Question	Answer
<p>Where can I consult the IFEMA MADRID General Rules of Participation to which my participation is subject?</p>	<p>In addition to the Exhibitor's Guide, participation in C&R is subject to IFEMA MADRID's General Rules of Participation, which you should be informed about and which you can access on the IFEMA MADRID website (www.ifema.es) and via the following link IFEMA MADRID General Rules of Participation.</p>
<p>Can I hire a catering service or serve my own food and beverages at the stand?</p>	<p>Yes. Exhibitors who are going to offer a catering service at their stand (free of charge), can do so either by submitting their application with the approved catering companies at IFEMA MADRID (See the list HERE) or through other catering service providers, in which case it is essential to fill in the form "Notification for the provision of catering services on stands" available in the exhibitors' area of the institutional website and send it, with the information requested therein, to: catering@ifema.es for its information and appropriate ends.</p> <p>If IFEMA MADRID has not been notified, the Exhibitor will not be able to offer this service on their stand.</p> <p>The Exhibitor assumes responsibility for third-party complaints that are caused by said catering service, and expressly exempts IFEMA from any liability in this regard.</p>
<p>Can I extend the trade fair day by having a fun afterwork on my stand after the at my stand after the end of the fair ?</p>	<p>The holding of a recreational afterwork outside exhibition hours is subject to prior authorisation. They may only be held on 18 and 19 November, at the close of the fair (7.00 pm) until 9.00h pm</p> <p>It is essential to send the request for authorisation to cr@ifema.es</p>
<p>Can I access the trade fair centre with vehicles for assembly and disassembly or loading and unloading of goods?</p>	<p>Access to IFEMA MADRID and to the inside of the halls will be done through the doors and on the days and times stated in this Exhibitor's Guide. The inside of pavilions will only be accessed to unload materials. Vehicles will not be able to park inside the halls or in the adjacent areas. We would like to remind you that, for safety reasons, it is strictly forbidden to park directly in front of the goods entrance.</p> <p>IFEMA MADRID takes no responsibility for the surveillance of vehicles while they are on the grounds of Feria de Madrid.</p> <p>There is a car park for trucks and another for private cars, which can be used by paying, where appropriate, the corresponding fees. Check rates</p>
<p>Can I have a vehicle on my stand?</p>	<p>Vehicles with a combustion engine used as part of an exhibition display must have a tank filled with the minimum fuel required to access the allocated space and be able to leave it at the end of the exhibition.</p>

2.6. FAQ's

Question	Answer
<p>Can I send goods to my booth?</p>	<p>IFEMA MADRID staff are not authorised to receive merchandise for your stand. In order to send merchandise to the venue, the exhibitor must indicate the delivery address: IFEMA MADRID (Avda. del Partenón, 5. 28042 Madrid. Spain). C&R Trade Fair Name of your company. Hall and stand number.</p> <p>The merchandise must be received by your company's staff at your stand and arrive on the days set aside for incoming merchandise and decoration. If it is not possible to comply with the above, we recommend that you contact your freight forwarding partner: DB Schenker office at the IFEMA Trade Fair Centre MADRID: Hall 7, (+91) 330 51 77 ifema.madrid@dbschenker.com</p>
<p>What procedure do I have to follow to hang structures in the halls/rigging?</p>	<p>Exhibiting companies may hang elements from the ceiling of the halls following the procedure shown in the "Regulations for hanging structures in Halls" and by completing the form "Application for authorisation for hanging structures/rigging" and sending it to: inspeccion.rigging@ifema.es</p>
<p>Can I hold prize draws and raffles at the stand?</p>	<p>Raffles, prize draws, and random combination games are forms of gambling as set out in articles 3.2 and defined in article 15 of Law 6/2001 of 3 July on gambling in the Community of Madrid.</p> <p>All the information is available in the following form: https://sede.comunidad.madrid/comunicaciones-declaraciones/cifras-tombolas</p>
<p>How do I apply for a visa support letter?</p>	<p>Visa support letters are managed through the EXPO ZONE. To do so, you first have to personalise your exhibitor passes. Once you have managed your exhibitor passes, you can request your support letters and download them to your computer.</p> <p>It is essential to be up to date with payments according to the payment schedule in order to be able to apply for the letters.</p>
<p>Where can I book the services for my stand?</p>	<p>Either through the e-commerce section inside the EXPO ZONE or via the link: https://shop.ifema.es</p>
<p>Who do I contact to book a room?</p>	<p>Exhibitors who need to book a room should contact with: uanproduccion@ifema.es</p>

2.6. FAQ's

Question	Answer
<p>What does the CONECTA PLAN (formerly the Marketing and Communication Pack + C&R LiveConnect) include?</p>	<p>This mandatory concept includes the following promotional elements:</p> <ul style="list-style-type: none"> • Access to C&R LIVE Connect. • Presence in the exhibitors' catalogue available on the official website of the event. • Presence on the plans located at the entrance to each of the halls. <p>And the following services:</p> <ul style="list-style-type: none"> • Access to the EXPO ZONE. • Exhibitor passes according to the stand area booked. • Invitations and delivery service through the EXPO ZONE. • Wi-Fi connection for 3 users during the entire trade fair for stand holders (Devices that allow 5GHz network capability). Access codes will be sent out during the lead up to the event.
<p>How to use the EXPO ZONE?</p>	<p>The following video shows a tutorial on the use of the EXPO ZONE</p>
<p>What are the features of my EXPO ZONE?</p>	<p><u>EXPO ZONE</u>: It is used to manage the participation of each exhibiting company at C&R</p> <ul style="list-style-type: none"> • Manage the contacts who will access the EXPO ZONE. • Access the exhibitor's calendar. • Visualise documents of interest. • Arrange exhibitor passes, request visa support letters and send invitations. • Register co-exhibitors. • Access payments, statement of accounts and invoices issued. • Upload free design stand projects. • Add signage and choose the colour of the carpeting for modular stands. • Access the e-commerce section for booking services.

2.6. FAQ's

Question	Answer
<p>What are the features of my LIVEConnect?</p>	<p>LIVE Connect: A digital platform that facilitates connections with other professionals and exhibitors</p> <ul style="list-style-type: none"> •Update the company details that are visible in the catalogue and in C&R LIVE Connect. •Show the range of products and services on offer. •Schedule appointments for professional meetings. •Sign up other team members with access to LIVE Connect. •Complete your professional profile on the platform and my schedule of availability for meetings. •Search for contacts of interest in the professional network. •Consult the activities with the possibility of scheduling them. •Display information on what other exhibitors are offering. •Scan professional visitor passes at the fair. •Request and agree to be contacted for chat and videocall.
<p>How can I request my invoices?</p>	<p>Invoices are not generated by default. You must request them directly from the IFEMA MADRID invoicing department (servifema@ifema.es) indicating the event at which you are exhibiting and the items to be included in the invoice. Once it has been generated, it will be available in your EXPO ZONE.</p>
<p>What is the difference between floor only and turnkey stand basic?</p>	<p>The floor-only system only includes the booking of the stand space and the mandatory elements (insurance, minimum electricity consumption, assembly fee and Communication and Marketing Pack + LIVEConnect), and it is down to the exhibitor to create a free-design stand or hire it through the stand design service offered by IFEMA MADRID.</p> <p>The turnkey stands are delivered assembled. The stand structure is made of aluminum and melamine panels. You can see the detailed characteristics under point 1.6</p>

2.6. FAQ's

Question	Answer
Can I decorate and/or set up my stand with IFEMA?	<p>Yes, IFEMA MADRID offers two main services:</p> <p>Graphic decoration for stands: Customise your modular stand with your brand image for maximum visitor impact. There is a wide range of versatile graphic materials adaptable to walls, furniture, front, banners... You can request information and a quote at: decoraciongrafica@ifema.es</p> <p>Stand design: this consists of a comprehensive stand design service fully adapted to your needs. From the planning of your space, design, assembly and disassembly. You can request information and a quote at: infodesign@ifema.es</p>
Is it compulsory to attend the booth at all times?	<p>Yes, exhibitors must not leave their stand unattended and must remain with the products on display throughout the entire period and opening hours of the event.</p>
Are assembler's passes necessary during the set-up of the trade fair?	<p>No. The requirements to be allowed to enter and set up are: to have paid 100% of your participation, to have the project presented and approved, to have paid the assembly fees, and to have completed the occupational risk protocol.</p>
How can I book parking at IFEMA?	<p>Exhibiting companies will be able to book parking spaces through the e-commerce section inside the EXPO ZONE or via the link https://shop.ifema.es. Once the contract has been signed, parking badges can be collected from November 12 (first day of stand set-up) at the exhibitor services desk, located in the central boulevard between halls 6 and 8.</p>

2.6. FAQ's

Question	Answer
What coverage do I have as an exhibitor with the insurance included?	You can check the coverage of the compulsory insurance policies at the IFEMA MADRID exhibitor support area .
How can I access the WI-FI network as an exhibitor?	As an exhibitor you will receive as part of the CONNECT PLAN a Wi-Fi connection for 3 users during the entire trade fair for the exclusive use of stand holders. Devices that allow 5GHz network capability are required. Access codes will be sent out during the lead up to the event. Additional Wi-Fi access can be booked through the e-commerce section inside the EXPO ZONE or via the link https://shop.ifema.es
Regulations and support for exhibitors at the trade fair centre	https://www.ifema.es/en/support/exhibitors-ifema-fairgrounds
Regulations and support for fitters at the trade fair centre	https://www.ifema.es/en/support/assemblers-colaborators-fairgrounds

3.1 Exhibitor catalogue

The fair's catalogue, or list of exhibiting and co-exhibiting companies, is an essential tool for promotion and networking. It provides visitors and other exhibitors with the basic information needed to prepare for the fair and helps them find and contact you before, during, and after the event.

- Enter and update your contact details, the products or services presented, and any relevant information to give your company maximum visibility and ensure you get the most return from your participation.
- All the digital environment and communication for your participation is channeled through Live Connect.
- Make the most of the platform offered by IFEMA to promote your participation, schedule appointments, showcase your products, and connect with your target audience.

3.2 Invitations for your clients and contacts

IFEMA provides you with access invitations to the fair to efficiently promote your participation. Don't miss out on this useful tool, which is available to you in your Expo Zone.

3.3 Networking

Enhance your contact list. LIVE Connect gives you the opportunity to search for contacts among its participants. You can use filters such as country, activity, job title, products of interest, etc., to perform searches. Once you've identified potential clients, you can chat with them, request contact details (such as email and phone number), or invite them to a meeting at the fair.

Be proactive and take advantage of this opportunity to build a valuable contact list.

Meeting requests can be directed to the company in general or to a specific team member. This way, the entire team can plan their meeting schedule at the fair in advance.

3.4 Outdoor advertising

We offer you a wide range of strategically placed advertising spaces, ensuring maximum visibility for visitors and exhibitors attending the fairgrounds. You can explore these options on the fair's website in the exhibitor area under "advertising services and promotional elements," or by sending an email to publicidad@ifema.es or by calling (+34) 91 722 53 08 / 40.

3.5 Innovation gallery

The Innovation Gallery aims to offer added value to exhibitors and visitors by showcasing a selection of new products, giving maximum visibility to cutting-edge innovations in the sector.

To participate, you must be an exhibitor at C&R 2025 and hold the commercial rights or patent for the product being presented, or have the express written consent of the company owning the patent. A fee of €770 + VAT (1) per registered product is required. This fee is mandatory and non-refundable, regardless of whether the product is included in the Innovation Gallery.

You can submit your application once you receive the call and guidelines for the current edition.

4. Sustainability Culture Management at IFEMA MADRID

C&R

At IFEMA MADRID we are not only fully committed to sustainability per se, but also to achieving the sustainable development goals (hereinafter SDGs) promoted by the United Nations, which we have incorporated into our strategic corporate management policy and culture

IFEMA MADRID's sustainability policy is mainly focused on the following SDGs: 8, 9, 11, 12, 13, 16 and 17.

IFEMA MADRID'S sustainability policy is mainly based on the following SDGs: Nos. 8, 9, 11, 12, 13, 16 and 17.

ISO Standards certified by IFEMA MADRID:

- ISO 9001: Quality Management,
- ISO 20121: Event Sustainability Management.
- ISO 14001: Environmental Management,
- ISO 50001: Energy Management,
- ISO 22320: Emergencies Management.

ACTIONS TAKEN AT IFEMA MADRID TO REDUCE GAS EMISSIONS AND BE MORE ENERGY EFFICIENT:

- 100% certified electrical energy of renewable origin.
- Geothermal installation in Puerta Sur building.
- Low consumption lighting in our halls and on our modular stands.
- Controlling the temperature of our air-conditioning / HVAC systems.

IFEMA MADRID is in possession of "calculo" (I calculate) and "reduzco" (I reduce) stamps in Carbon Footprint Scopes 1 and 2.

WASTE MANAGEMENT:

• The exhibitor/assembler is the generator of the waste and shall therefore be responsible for its removal and management. How the waste generated by the exhibitor is managed is explained in article 35 of the General Rules of Participation.

• We offer our exhibitors a service that includes the removal and management of the waste they/their assemblers generate. (check our fees in Exhibitors' Area).

Carpet recycling:

IFEMA MADRID recycles 100% of the carpeting used in aisles and communal areas. To do so it has been essential to change our assembly and disassembly process, that affects the entry and removal of goods (check the corresponding item) . Furthermore, means that it has to be laid in strips instead of covering the entire surface area as was previously the case. This means we can guarantee its conversion into a new raw material for the subsequent manufacture of other products.

SUSTAINABLE MOBILITY:

IFEMA MADRID offers access to public transport close to its facilities (metro and bus), parking for electric cars with 100% renewable electricity charge points, as well as a parking area for bicycles and scooters

GUIDE TO SUSTAINABLE PARTICIPATION IN TRADE FAIRS/EVENTS:

IFEMA MADRID has published its Guide to Sustainable Participation in Trade Fairs for exhibitors on its website. We recommend you read it before starting to prepare your participation:

ifema.es/en/about-us/quality-sustainability



Department	Ask me about	Contact	
<p>Commercial Department</p>	<ul style="list-style-type: none"> Contracting space General topics of participation in the fair Exhibitor passes Trade visitor invitations Activities and forums at the Fair. 	<p>Director</p>	<p>María Valcarce</p> <hr/> <p>Commercial Managers</p> <p>M. Cruz Martín - <i>Industrial and Commercial Refrigeration Area</i></p> <p>Marta Hernández - <i>HVAC Area</i></p> <hr/> <p>Coordinator</p> <p>Clara Martín</p> <hr/> <p>Commercial Area</p> <p>M^a Ángeles Llorente</p> <p>Macarena Ferrer</p>
<p>IFEMA MADRID Customer Service</p>	<ul style="list-style-type: none"> Hiring of services Expo Zone Visitor information 	<p>(+34) 91 722 30 00</p> <p>atencionalcliente@ifema.es</p>	
<p>Technical Secretariat (Trade Fair Services Department)</p>	<ul style="list-style-type: none"> Technical support to exhibitors and assemblers Review of stand assembly projects Solutions to technical problems during the exhibition activity Customization of modular stands 	<p>(+34) 91 722 30 00</p> <p>stecnica@ifema.es</p>	
<p>Graphic decoration</p>	<p>Hiring of graphic materials to customize your booth</p>	<p>(+34) 91 722 30 00</p> <p>decoraciongrafica@ifema.es</p>	
<p>Full service stand design</p>	<p>Design and assembly of free design stands</p>	<p>(+34) 91 722 30 00</p> <p>infodesign@ifema.es</p>	

Department	Ask me about	Contact		
Outdoor Advertising	Hiring of advertising media at the fairgrounds	(+34)91 722 53 40/08 publicidadexterior@ifema.es		
Communication and Marketing Management	Media relations	<table border="0"> <tr> <td data-bbox="1402 727 2092 958"> Director: Raúl Diez Directora de Comunicación: Marta Cacho Jefe de Prensa: Alejandra Elorza Prensa Internacional: Elena Valera Secretaria Prensa: Pilar Serrano </td> <td data-bbox="2092 727 3022 958"> (+34)91 722 50 93 aelorza@ifema.es </td> </tr> </table>	Director: Raúl Diez Directora de Comunicación: Marta Cacho Jefe de Prensa: Alejandra Elorza Prensa Internacional: Elena Valera Secretaria Prensa: Pilar Serrano	(+34)91 722 50 93 aelorza@ifema.es
Director: Raúl Diez Directora de Comunicación: Marta Cacho Jefe de Prensa: Alejandra Elorza Prensa Internacional: Elena Valera Secretaria Prensa: Pilar Serrano	(+34)91 722 50 93 aelorza@ifema.es			
Planning and Control Management	<ul style="list-style-type: none"> Rental of the different meeting and convention spaces at the fairgrounds, both during and outside the fairs. Coordination of extra-fair activities 	(+34)91 722 30 00 uanproduccion@ifema.es		
Institutional Relations (Protocol)	<ul style="list-style-type: none"> Institutional visits Guided tours Protocol for all Events Institutional relations 	(+34)91 722 30 00 infoifema@ifema.es		
Safety and Self-Protection Management	<ul style="list-style-type: none"> General security and parking Access to the Fairgrounds Coordination for stand catering 	(+34)91 722 50 65 dseguridad@ifema.es catering@ifema.es		
Medical Service and Security Emergencies	<ul style="list-style-type: none"> Medical emergency Health care for exhibitors and visitors during the celebration of fairs, set-up and dismantling. 	(+34)91 722 54 00		

Thank you

